

COMPLI 1200 HL SEWAGE LIFTING STATIONS

- NEW: With modern HighLogo microprocessor control unit
- Ready to connect
- Submersible
- Height-variable inlet
- Duplex swing-type check valve
- PE-tank 350 l
- Smart Home capable



DESCRIPTION

With their performance graduations, the compli 1200 lifting stations has been designed for larger storage capacities, if wastewater of several residential units or wastewater from commercial enterprises, for example, have to be disposed of. During the design work, special attention was given to easy handling, space-saving erection and uncomplicated installation.

A fitting (to be provided by the customer) can be used at the rear inlet port of the stage housing to mount the unit variably in height (560 to 700 mm) as well as capable of rotating (180 °).

The submergible unit is permitted for general use in areas subject to flooding without requiring additional outlay. The control unit has to be fitted in a well ventilated flood-proof room.

The construction with PE tank has freely accessible drains and a clamp-type inlet flange for easy installation. The top-mounted cleaning opening and the easy replaceability of the pre-mounted pumps also ensure time-saving servicing. Duplex systems have two pump units on one tank which are switched alternately or, if required, they are operated both in order to cope with peak load or reserve operation. This automatic switching sequence increase safety in particular for use in commercial or public buildings and is always required in keeping with German/ European standard EN 12056-4, when the wastewater inflow must not be interrupted.

The sewage lifting stations are available with modern microprocessor control units (HighLogo). The control can be configured intuitively and flexibly via the large graphic display in conjunction with the multifunction button. With optional accessories (GSM modem), SMS or e-mail transmission is also possible in the case of a malfunction.

The compli sewage lifting station can be integrated into a smart infrastructure. The FTJP radio transmitter is connected to the potential-free contact of the lifting station. It is now possible to transmit the switching status (e. g. an alarm message) to an EnOcean-capable smart home gateway (Wibutler, Afriso, Homee).

PERFORMANCE

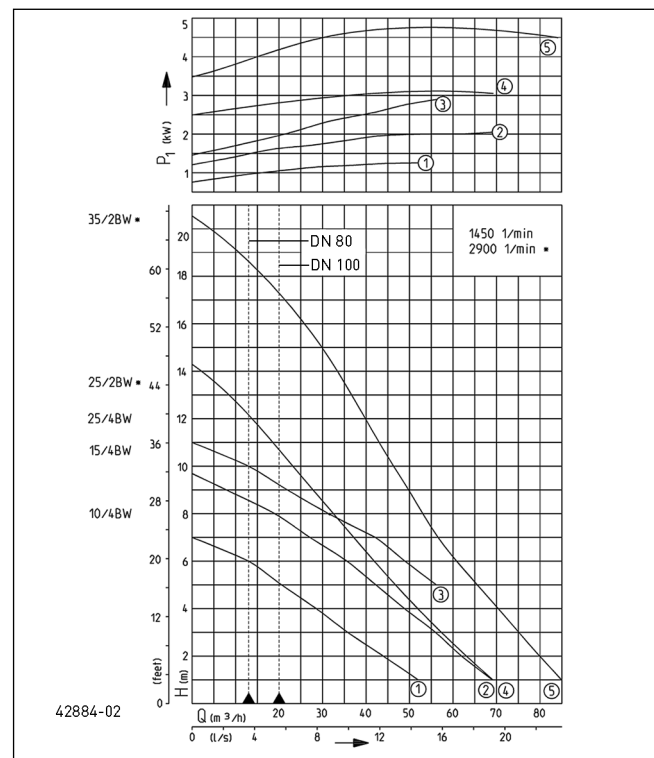

Type	Delivery head H [m]	1	2	3	4	5	6	7	8	9	10	11	13	15	17
complli 1210/4 BW HL	Flow rate Q [m³/h]	52	44	37	29	22	13								
complli 1215/4 BW HL		69	62	56	49	42	36	27	19						
complli 1225/4 BW HL						56	49	42	32	22	13				
complli 1225/2 BW HL		69	64	58	52	47	42	37	33	28	23	20	8		
complli 1235/2 BW HL		85	80	75	71	66	62	57	54	50	47	44	36	30	21

We reserve the right to change specifications without notice. Pump performance is subject to ISO 9906 tolerances

The minimum flow velocity in the pressure piping must be 0.7 m/s according to EN 12056. This data is represented in the performance curve as a limit of application.



COMPLI 1200 HL

SEWAGE LIFTING STATIONS

SCOPE OF SUPPLY

Ready-to-connect sewage disposal unit in keeping with German/European standard EN 12050 with DN 150 clamp-type inlet flange, pre-mounted submersible pump (two pumps in duplex system) and DN 80 connecting flange with pipe unit. Ø110, reducer ring Ø 110 to Ø 90, pre-mounted duplex swing-type check valve, one elastic connection each with clamps for plastic pressure pipe and ventilation pipe, automatic level control. Control unit (IP 44 type of protection) with motor protection, contactors, transformer, mains-dependent alarm

system and potential noc-contact for collective failure messages, with optical display of sense of rotation, alarm and operation as well as two manual-0-automatic switch. With automatic changeover system and peak load function and further functions such as operating hours counter and maintenance interval display.

Cable: between tank and control 4 m, between control and plug 1.5 m.

MECHANICAL DATA

Pump	Vertical single-stage	Motor housing	Grey cast iron
Free passage	70 mm	Pump housing	Grey cast iron
Pressure pipe	DN 100	Submersible	Yes
Bearing	Ball bearings, grease-lubricated	Pressure outlet	DN 80
Impeller	Vortex impeller, grey cast iron	Tank capacity	350 l

ELECTRICAL DATA

Voltage	3/N/PE-400 V	Type of enclosure	IP 68
Power line	4m H07RN-F	Insulation class	F
Wires	6G1,5	Winding thermostat	Yes

COMPLI 1200 HL

Type	Code No.	Motor rating		Current	Plug	Oil chamber	Weight
		P1	P2				
compl 1210/4 BW HL	JP50118	1.3 kW	1.0 kW	2.8 A	CEE-16A	No	133 kg
compl 1215/4 BW HL	JP50119	2.2 kW	1.7 kW	3.9 A	CEE-16A	No	134 kg
compl 1225/4 BW HL	JP50120	3.0 kW	2.2 kW	5.1 A	CEE-16A	No	143 kg
compl 1225/2 BW HL	JP50121	3.3 kW	2.6 kW	5.4 A	CEE-16A	Yes	143 kg
compl 1235/2 BW HL	JP50122	4.8 kW	4.0 kW	8.2 A	CEE-32A	Yes	158 kg

COMPLI 1200 HL

SEWAGE LIFTING STATIONS

Dimensions compli 1200 (mm)

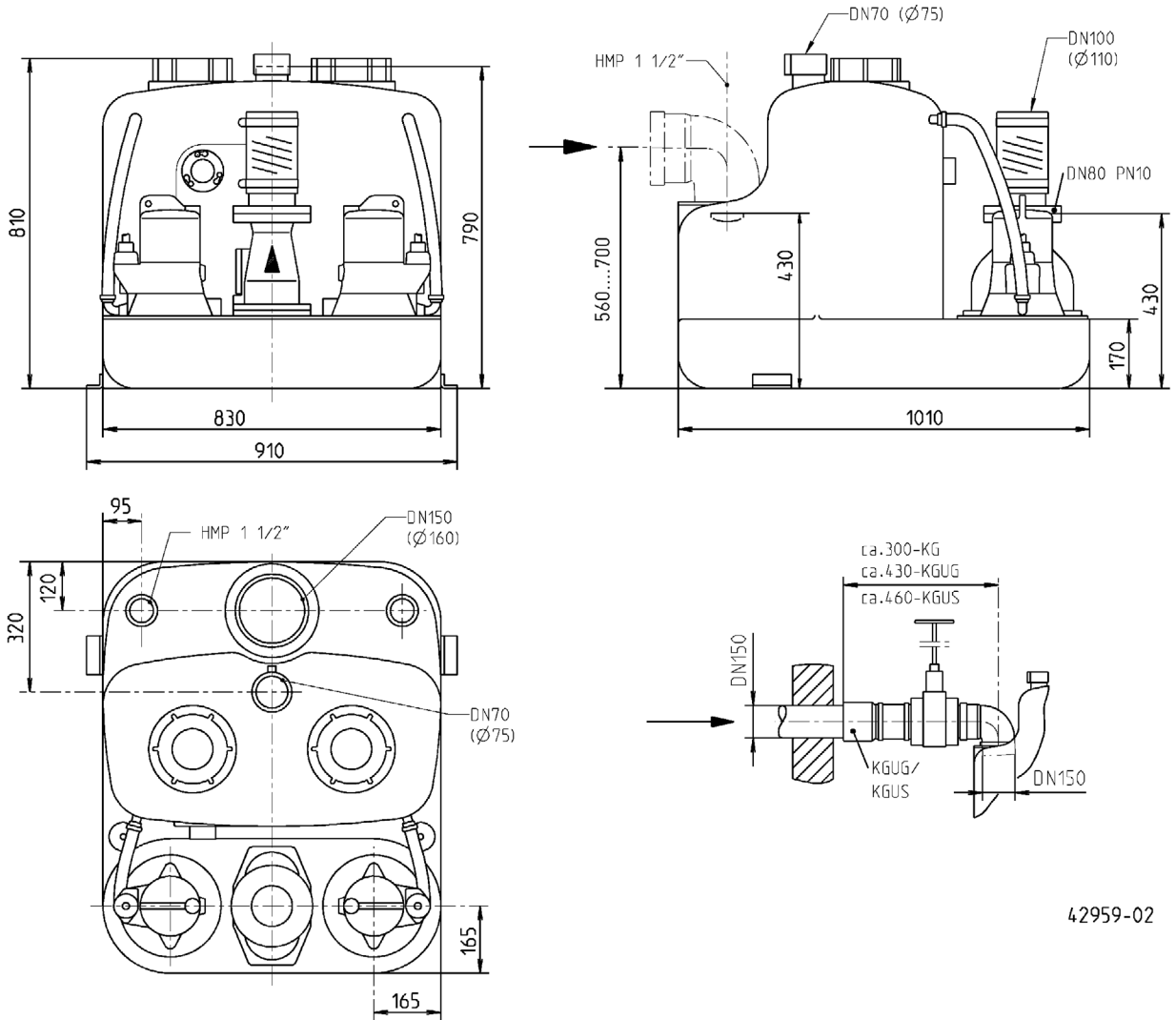

42959-02

COMPLI 1200 HL

SEWAGE LIFTING STATIONS

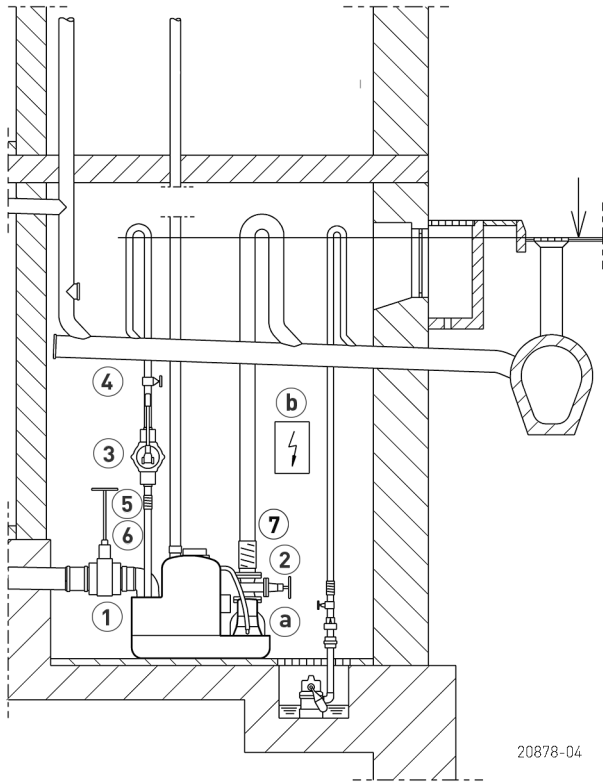

Example of installation



All types have DN 80 / PN 10 connecting flange, however with pipe socket DN 100. For this reason, a non-return valve for the pressure pipe need to be chosen for DN 80 only in case of direct erection. The ownstream pressure pipe is connected to DN 100 by an elastic connection. Sewage lifting stations are to be used for the transport of faecal matter and domestic wastewater in building drainage systems as described in German standard DIN 1986 T3. In keeping with the stipulations of German / European standard EN 12056-4 they

have to be mounted with collecting tanks inside building permitting a free space of 60 cm for operation and repair. The pressure pipe has to be passed above the locally defined backpressure level and a non-return valve tested in keeping with German / European standard 12050-4 has to be mounted. In keeping with German / European standard 12056 the ventilation pipe has to be passed up to the roof. EN 12056 paragraph 5.1 In applications where the waste-water inlet must not be interrupted a double system has to be installed.

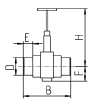
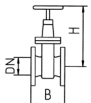
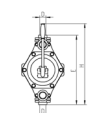
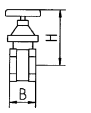
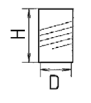

MECHANICAL ACCESSORY

				Code No.
	① Inlet gate valve PVC	with two pipe sockets, DN 150, PN2.5	660x450 (HxW)	JP28591
	② Sluice valve	DN 80, PN 10, EN 1171	315x180 (HxB)	JP00639
	③ Hand diaphragm pump	for emergency purposes (up to H geod 15 m)	640x1½" (HxD)	JP00255
	④ Stop valve	brass, 1½" (DN 40), PN 16	125x60 (HxB)	JP44786
	⑤ Elastic connection	1½" (DN 40), PN 4	120x50 (HxD)	JP44777
	⑥ Hose band clamp	1½"		JP44763
	⑦ Adapter ring	DN 100-DN 80 SML		JP50174

COMPLI 1200 HL

SEWAGE LIFTING STATIONS

ELECTRICAL ACCESSORY

			Code No.
	a Seal leak detector	DKG	JP44900
	b Rechargeable battery	for mains independent alarm	JP44850
	c Smart Home	FTJP radio transmitter	JP47209

COMPLI 1200 HL

SEWAGE LIFTING STATIONS